

SlamAIR

MN-406
(02804)
ECR 6370

P/N 59202

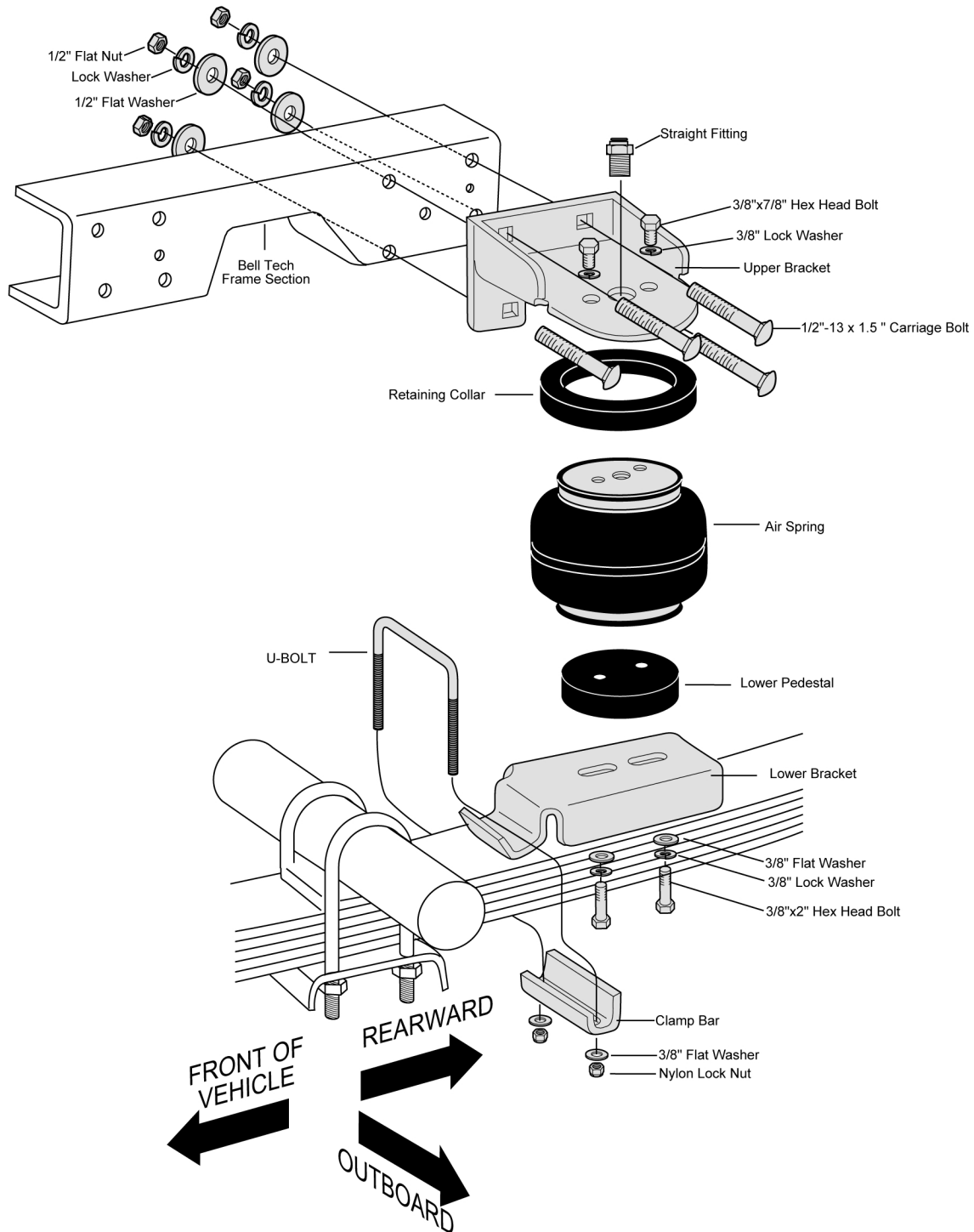

Figure 1

Figure 1 represents a TYPICAL installation. Your vehicle may look slightly different due to make, model, or year.

WARNING

DO NOT INFLATE ASSEMBLY WHEN IT IS UNRESTRICTED. ASSEMBLY MUST BE RESTRICTED BY SUSPENSION OR OTHER ADEQUATE STRUCTURE. DO NOT INFLATE BEYOND 100 P.S.I. IMPROPER USE OR OVER INFLATION MAY CAUSE ASSEMBLY TO BURST CAUSING PROPERTY DAMAGE OR SEVERE PERSONAL INJURY.

Please read these instructions completely before attempting the installation.

This kit is designed to bolt onto the Bell Tech notched frame section through existing holes BEHIND the axle.

Failure to maintain minimum air pressure of 5 p.s.i. in the air spring, bottoming out or over extension will void the warranty.

IMPORTANT - In no case should the air spring be the suspension limiter in either extension or compression. Most vehicles will have a hard rubber compression stop on the rear suspension. The shock absorber is usually the limiter in full extension.

IMPORTANT:

Your vehicle may be equipped with a rear brake proportioning valve. Any type of load assist suspension product could affect brake performance. We recommend that you check with your dealer before installing this type of product. If your vehicle does not have a proportioning valve or is equipped with an anti-lock brake system, no adjustment or modification is required.

1. Jack up rear of vehicle or raise on hoist and remove rear wheels.
2. Remove the four REAR mounting bolts, nuts and washers from the side of the frame rail through the BellTech C-section re-inforcement brace. The SlamAir upper bracket is designed to bolt into these existing holes in the BellTech C-section BEHIND the axle.
3. Install the straight fitting into the air port on the top of the air spring finger tight plus two turns. Place the retaining collar on top of the air spring. Insert the carriage bolts into the lower holes of the upper bracket and attach the air spring to the upper bracket with the 3/8" lock washer and 3/8"-16x7/8" hex head bolts. Tighten to 15 ft. lbs.
4. The lower brackets are marked left and right, left for the driver side and right for passenger side. The slots in the lower bracket must be offset outboard towards the tire. Position the hook of the lower bracket in relationship to the upper bracket as shown in Figure 2.
5. Place the lower pedestal on the bottom of the air spring and attach the lower bracket to the spring using the 3/8" flat washer, 3/8" lock washer and 3/8"-16X2" hex head bolt. LEAVE LOOSE FOR LATER ADJUSTMENT.
6. Set the left side unit on the driver side leaf spring and insert the carriage bolts through the existing holes in the frame rail. The lower bracket is slotted for front to back adjustment. Push the lower bracket forward until it contacts axle or spring retainer bracket. Mark the location of the air spring on the bracket, remove the assembly and tighten the lower mounting bolts to 15ft. lbs.

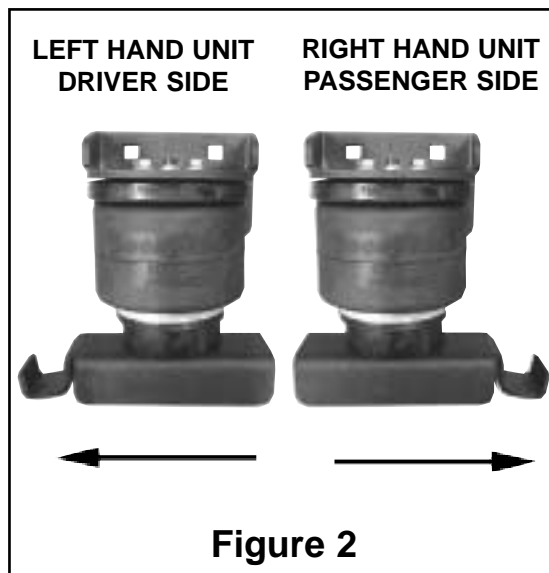

Figure 2

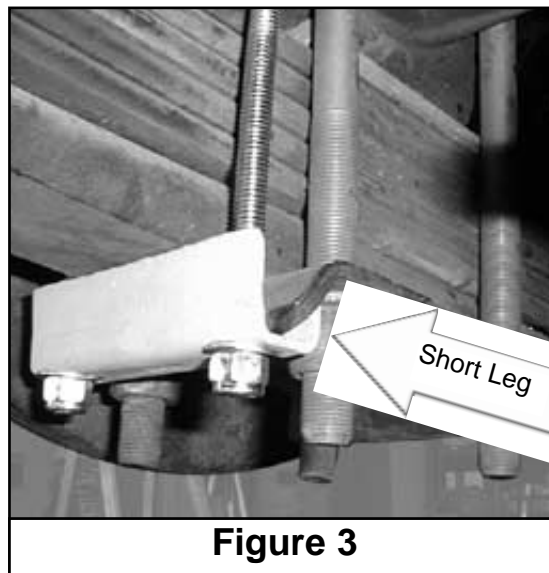

Figure 3

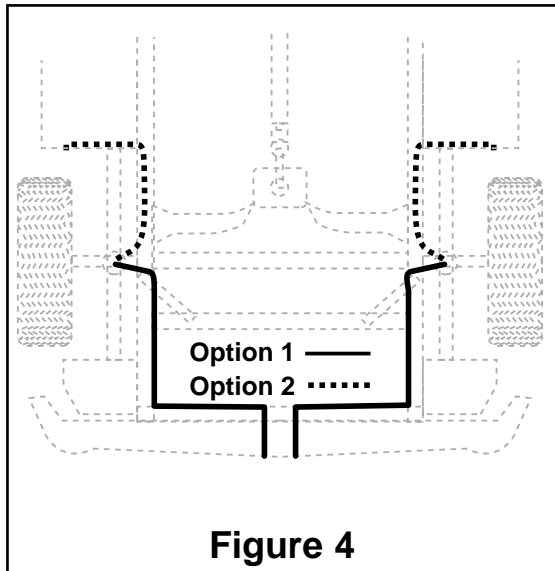

Figure 4

7. Set the assembly back on the leaf spring. Attach the upper bracket to the frame rail using 1/2"x1.5" carriage bolts, flat washers, lock washers and 1/2" nuts. Tighten to 50 ft. lbs.
8. Attach the lower bracket by inserting the U-bolt over the front of the lower bracket, slide the clamp bar onto the U-bolt with the short leg of the clamp bar forward. The short leg of the clamp bar must be locked under the edge of the spring retainer bracket (Figure 3). Install 3/8" flat washer and 3/8" lock nuts. Tighten to 20 ft. lbs.
9. Repeat steps 2 through 8 for the passenger side.
10. Select a location for the inflation valves in the rear bumper area or rocker panel flange insuring that each valve will be protected and accessible with an air hose (Figure 4).
11. Use a standard tube cutter, a razor blade, or very sharp knife to cut the air line in two equal lengths. A clean square cut will ensure against leaks. Drill 5/16" hole for inflation valve and mount as illustrated. Rubber washer on outside is for weather seal (Figure 5).

CAUTION: LEAVE SUFFICIENT AIR LINE SLACK TO PREVENT ANY STRAIN ON VALVE STEM DURING NORMAL AXLE MOTIONS.

8. Route air line along frame to desired inflation valve location (Figure 4). Attach air line to chassis with the provided plastic straps.

TO PREVENT AIR LINE FROM MELTING, KEEP IT AT LEAST TWELVE INCHES FROM EXHAUST SYSTEM.

9. Cut off excess air line squarely. Install the air line into the fitting. This is a self locking fitting. Push and slightly turn the cut end of the air line into the fitting as far as it will go. You will hear/feel a definite "click" when the air line is seated. The air line is now installed. Air line will go in 5/8 inch.

10. Repeat process for right side.

12. Inflate to 30 p.s.i. Check all fittings and valve core with a soapy water solution for leaks. Check once again to be sure you have proper clearance around the air spring. When the air spring is inflated there must be sufficient clearance all around the air spring.

13. Recheck air pressure after 24 hours. A 2-4 p.s.i. loss after initial installation is normal. If pressure has dropped more than 5 lbs. re-test for leaks with soapy water solution. Please read and follow the Maintenance and Operating Tips.

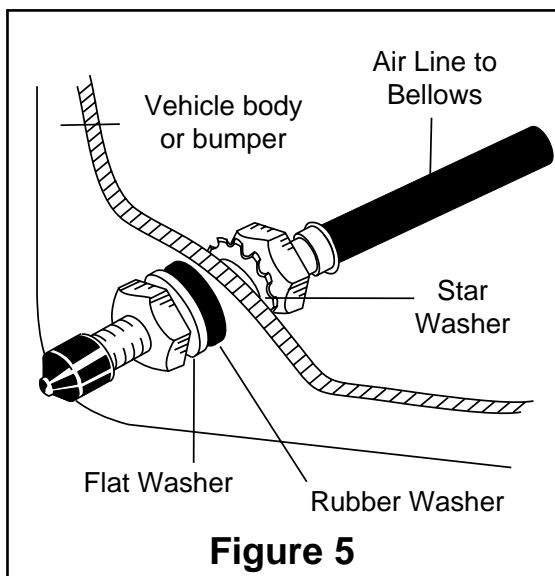

Figure 5



Product Use Information

Frequently asked questions

Q. Will installing air springs increase the weight ratings of a vehicle?

No. Adding air springs will not change the weight ratings (GAWR, GCWR and/or GVWR) of a vehicle. Exceeding the GVWR is dangerous and voids the Air Lift warranty.

Q. Is it necessary to keep air in the air springs at all time and how much pressure will they need?

The minimum air pressure should be maintained at all times. The minimum air pressure keeps the air spring in shape, ensuring that it will move throughout its travel without rubbing or wearing on itself.

Q. Is it necessary to add a compressor system to the air springs?

No. Air pressure can be adjusted with any type of compressor as long as it can produce sufficient pressure to service the springs. Even a bicycle tire pump can be used, but it's a lot of work.

Q. How long should air springs last?

If the air springs are properly installed and maintained they can last indefinitely.

Q. Will raising the vehicle on a hoist for service work damage the air springs?

No. The vehicle can be lifted on a hoist for short-term service work such as tire rotation or oil changes. However, if the vehicle will be on the hoist for a prolonged period of time, support the axle with jack stands in order to take the tension off of the air springs.

Tuning the air pressure

Pressure determination comes down to three things — level vehicle, ride comfort, and stability.

1. Level vehicle

If the vehicle's headlights are shining into the trees or the vehicle is leaning to one side, then it is not level (fig. 1). Raise the air pressure to correct either of these problems and level the vehicle.

2. Ride comfort

If the vehicle has a rough and harsh ride it may be due to either too much pressure or not enough (fig. 2). Try different pressures to determine the best ride comfort.

3. Stability

Stability translates into safety and should be the priority, meaning the driver may need to sacrifice a perfectly level and comfortable ride. Stability issues include roll control, bounce, dive during braking and sponginess (fig. 3). Tuning out these problems usually requires an increase in pressure.

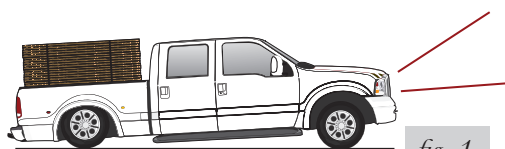

Bad headlight aim

fig. 1



Sway and body roll

fig. 2

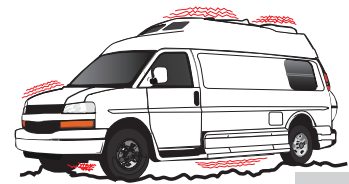

Rough ride

fig. 3

Guidelines for adding air:

1. Start with the vehicle level or slightly above.
2. When in doubt, always add air.
3. For motorhomes, start with 50-100 PSI in the rear because it can be safely assumed that it is heavily loaded.
4. If the front of the vehicle dives while braking, increase the pressure in the front air bags, if equipped.
5. If it is ever suspected that the air bags have bottomed out, increase the pressure (fig. 4).
6. Adjust the pressure up and down to find the best ride.
7. If the vehicle rocks and rolls, adjust the air pressure to reduce movement.
8. It may be necessary to maintain different pressures on each side of the vehicle. Loads such as water, fuel, and appliances will cause the vehicle to be heavier on one side (fig. 5). As much as a 50 PSI difference is not uncommon.

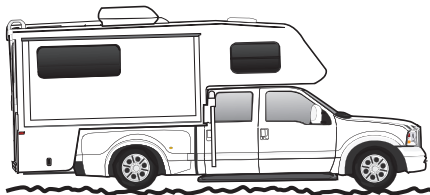

Bottoming out

fig. 4

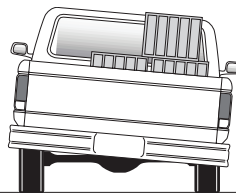

Unlevel

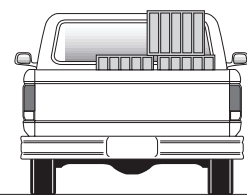

Level

fig. 5

Warranty and Returns Policy

Air Lift Company warrants its products, for the time periods listed below, to the original retail purchaser against manufacturing defects when used on catalog-listed applications on cars, vans, light trucks and motorhomes under normal operating conditions for as long as Air Lift manufactures the product. The warranty does not apply to products that have been improperly applied, improperly installed, used in racing or off-road applications, used for commercial purposes, or which have not been maintained in accordance with installation instructions furnished with all products. The consumer will be responsible for removing (labor charges) the defective product from the vehicle and returning it, transportation costs prepaid, to the dealer from which it was purchased or to Air Lift Company for verification.

Air Lift will repair or replace, at its option, defective products or components. A minimum \$10.00 shipping and handling charge will apply to all warranty claims. Before returning any defective product, you must call Air Lift at (800) 248-0892 in the U.S. and Canada (elsewhere, (517) 322-2144) for a Returned Materials Authorization (RMA) number. Returns to Air Lift can be sent to: Air Lift Company • 2727 Snow Road • Lansing, MI • 48917.

Product failures resulting from abnormal use or misuse are excluded from this warranty. The loss of use of the product, loss of time, inconvenience, commercial loss or consequential damages is not covered. The consumer is responsible for installation/reinstallation (labor charges) of the product. Air Lift Company reserves the right to change the design of any product without assuming any obligation to modify any product previously manufactured.

This warranty gives you specific legal rights and you may also have other rights that vary from state-to-state. Some states do not allow limitations on how long an implied warranty lasts or allow the exclusion or limitation of incidental or consequential damages. The above limitation or exclusion may not apply to you. There are no warranties, expressed or implied including any implied warranties of merchantability and fitness, which extend beyond this warranty period. There are no warranties that extend beyond the description on the face hereof. Seller disclaims the implied warranty of merchantability. (Dated proof of purchase required.)

Air Lift 1000	Lifetime Limited
RideControl	Lifetime Limited
SlamAir	Lifetime Limited
LoadLifter 5000*	Lifetime Limited
EasyStreet Systems	1 Year Limited

Load Controller (I)	2 Year Limited
Load Controller (II)	2 Year Limited
SmartAir	2 Year Limited
Wireless AIR	2 Year Limited
Other Accessories	2 Year Limited

**formerly SuperDuty*

Notes

Notes

**FAILURE TO MAINTAIN MINIMUM PRESSURE, BOTTOMING OUT, OR
OVER EXTENSION WILL VOID THE WARRANTY**

MAINTENANCE/OPERATION	
MINIMUM AIR PRESSURE 5 P.S.I.	MAXIMUM AIR PRESSURE 100 P.S.I.
MAINTENANCE	
<ol style="list-style-type: none"> 1. Check pressure weekly. 2. Always maintain at least 5 p.s.i. air pressure to prevent chafing. 3. If you develop an air leak in the system, use a soapy water solution to check all air line connections and the inflation valve core before removing air spring. 	
OPERATING TIPS	
<ol style="list-style-type: none"> 1. Inflate your air springs to 60 p.s.i. before adding the payload. After vehicle is loaded, adjust your air pressure to level the vehicle and for ride comfort. 2. When you are carrying a payload it will be helpful to increase the tire inflation pressure in proportion to any overload condition. We recommend a 2 p.s.i. increase above normal (not to exceed tire manufacturer maximum) for each 100 lbs. total overload on the axle. 	
NOTE	
<ol style="list-style-type: none"> 1. IMPORTANT: For your safety and to prevent possible damage to your vehicle, do not exceed maximum load recommended by the vehicle manufacturer. Although your air springs are rated at maximum inflation pressure of 100 p.s.i., this pressure may represent too great of load on some vehicles. Check your vehicle owner's manual and do not exceed maximum loads listed for your vehicle. When inflating your Air Lift Springs, add pressure in small quantities, checking pressure frequently during inflation. The sleeves require much less air volume than a tire and therefore inflate much quicker. 2. Should it become necessary to raise the vehicle by the frame, make sure the system is at minimum pressure (5 psi) to reduce the tension on suspension/brake components. 	
<i>Thank you for purchasing Air Lift Products</i>	
	AIR LIFT COMPANY P.O. BOX 80167 Lansing, MI 48908-0167
FOR TECHNICAL ASSISTANCE CALL 1-800-248-0892	
Caution: DO NOT EXCEED THE VEHICLE MANUFACTURERS MAXIMUM GROSS VEHICLE WEIGHT RATING.	